

TGP

TECHNICAL GLASS PRODUCTS®
one source. many solutions.®

Fire-Rated Glazing



History of Fire-Rated Glass

History of Fire-Rated Glass

- Traditional wired glass
- Glass block
- Thin and wireless glass ceramic
- Transparent wall units

Presentation Overview

- Testing Components
- Fire Protective vs. Fire Resistive
- Labeling - New Labeling System for Fire-Rated Glass
- Non-Code Compliant Products

Fire-Rated Glazing Definition

Specialized glass designed to prevent the spread of flames and smoke.

- Glass earns fire ratings through rigorous testing processes at independent laboratories such as Underwriters Laboratories, Inc.® (UL)
- Fire-rated glazing for door and window assemblies are rated from 20 minutes to 3 hours
- The rating reflects the amount of time the material has been tested to remain in place to help stop the spread of fire and smoke

Two Key Purposes of Fire-Rated Glass

- Allows visibility into a space
- Prevents fire from spreading

Fire-Rated Glazing

Key Testing Components for Fire and Human Impact Safety

Fire Test - Measures the amount of time, in minutes or hours, that materials or assemblies can withstand fire exposure in a furnace.

Hose Stream Test - Heated glass and frames are subjected to water from a fire hose. The cooling, impact and erosion created by the hose stream tests the integrity of the glass and frames and eliminates inadequate materials.

Impact Safety Test - Measures the ability of glass to withstand impact. Ratings are given in levels based on the amount of force the glass can resist.

Impact Safety Test



Click on video to play

Safety Glazing Classifications

CPSC 16 CFR 1201 (Category II)

- 400 ft. lbs. pressure
- Tempered Glass, typical laminated glass, filmed glass

CPSC 16 CFR 1201 (Category I)

- 150 ft. lbs. pressure
- Permitted up to 1,296 in²

ANSI Z97.1 (Traditional Wired Glass Only)

- 100 ft. lbs. Pressure
- Permitted up to 1,296 in²

Fire Test

© 2010-2011 TECHNICAL GLASS PRODUCTS

Click on video to play

Hose Stream Test



Click on video to play

Types of Fire-Rated Glazing

FIRE PROTECTIVE

- Stop flames and smoke
- “Thin” glazing
- Traditional fire-rated material (wired glass, glass ceramic, hollow metal steel frames, etc.)
- Fire Windows: 45-90 Minutes
- Fire Doors: 20 minutes – 3 hours
- May not exceed 25% of the area of a common wall
- May not exceed 156ft²
- May not be used as “windows” in shaft condition



Types of Fire-Rated Glazing

FIRE RESISTIVE

- Stop flames, smoke, **AND** radiant heat (Both glass and frames)
- “Thick” glazing
- Classified as a “wall” rather than an opening (window)
- Both glass and frames must block passage of radiant heat

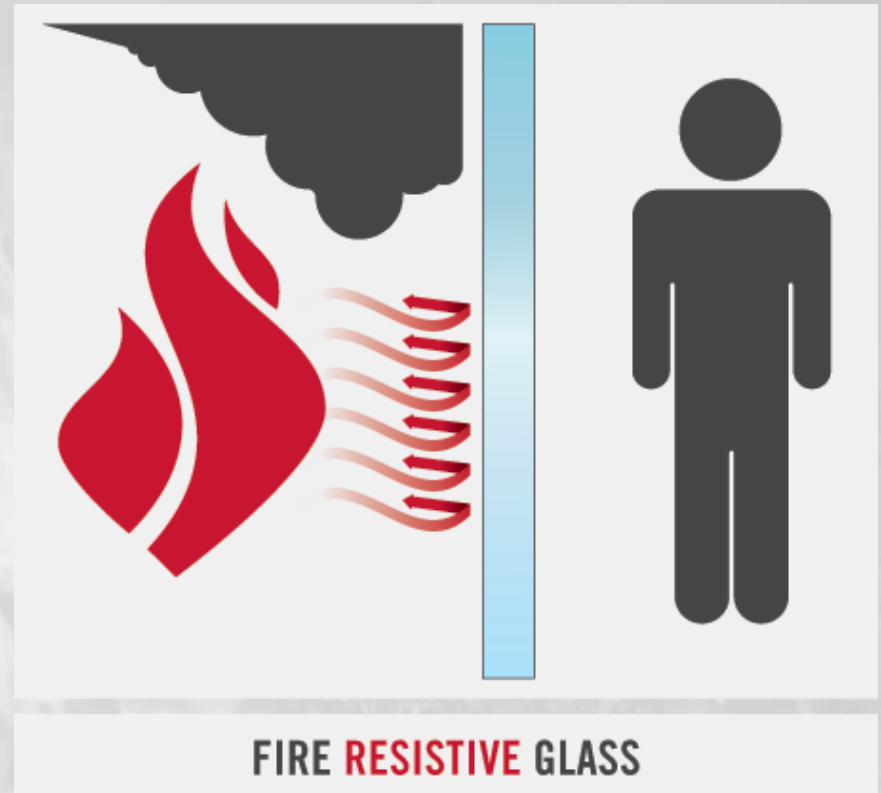

Labeling Requirements

Why is Fire-Rated Glazing Labeled?

- Enables code officials to accurately inspect glazing
- Owner, architect, facility manager can confirm they received correct product
- Fire Officials can plan safe evacuation methods
- Firefighters will understand the type of glass present in a building

Labeling Requirements

Labeling Methods

- Pilkington Method – Accepted by ICC in 2004
 - Labeled as a wall, opening or door (W, O, D)
 - Hose Stream Test (H)
 - Rating in minutes (20, 45, 60, 90, 120 min)
- European Method – Rejected by ICC
 - Labeled as integrity (E) or insulating (EI)
- Other proposal – Rejected by ICC
 - Protection (P) or Resistance (R)

Labeling Requirements

Label Background

- “W” indicates that the glass passes ASTM E119
 - This is the wall standard which includes temperature rise and hose stream
- “D” indicates that the glass passed NFPA 252
 - Door standard
- “O” indicates that the glass passed NFPA 257
 - Opening standard

Labeling Requirements

Fire-Rated Glass Manufacturer Label

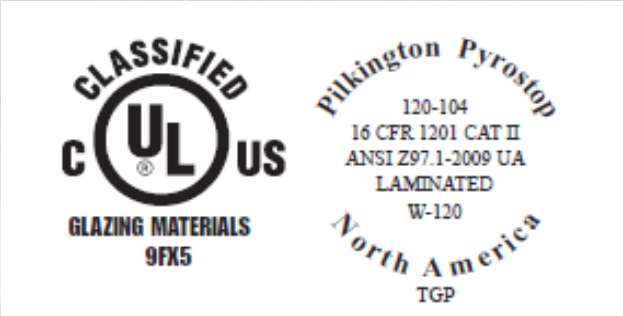

2" wide x .75" tall

Labeling Requirements

Fire-Rated Frame Manufacturer Label



Fireframes® Heat Barrier Series
by TGP
WALL DESIGN
FRAMING MEMBERS FIRE RESISTANCE CLASSIFICATION
SEE UL FIRE RESISTANCE DIRECTORY
FOR USE WITH UL DESIGN 533, SERIAL # _____
ALSO CLASSIFIED IN ACCORDANCE WITH UL-263, ASTM E-119

32W8
R-25274



Fireframes® Designer Series S
by TGP
SPECIAL PURPOSE FIRE DOOR & WINDOW FRAME ASSEMBLIES
FIRE RATING 60 MIN. SERIAL NO. _____
POSITIVE PRESSURE
ALSO CLASSIFIED IN ACCORDANCE WITH UL-10C

R-19207

Labeling Requirements



Labeling Requirements

UL Online Certifications Directory

- Available online at database.ul.com
- Search for UL File Number found on label for more information on listing

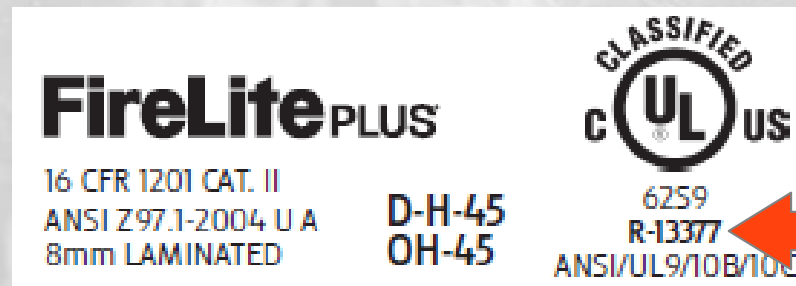

Labeling Requirements



ONLINE CERTIFICATIONS DIRECTORY

[Quick Guide](#) [Contact Us](#) [UL.com](#)

BEGIN A BASIC SEARCH

To begin a search, please enter one or more search criteria in the parameters below.

Company Name (options)	<input type="text"/>
City	<input type="text"/>
US State	Select a state <input type="text"/>
US Zip Code	<input type="text"/>
Country	Select a country <input type="text"/>
Region	Select a region <input type="text"/>
Postal Code (non-US)	<input type="text"/>
UL Category Code (options)	<input type="text"/>
UL File Number (help)	r13377 
Keyword	<input type="text"/>
<input type="button" value="SEARCH"/> <input type="button" value="CLEAR"/>	

TIPS FOR EFFECTIVE SEARCHES

Select a search method

- Match all words - type AND between words (i.e., display **and** nwgq)
- Match any word - type OR between words (i.e., hair dryer **or** blow dryer)
- Match phrase(s) - type exact phrase

ABOUT THE ONLINE CERTIFICATIONS DIRECTORY

You can use the UL Online Certification Directory to:

- Verify a UL Listing, Classification, or Recognition
- Verify a UL Listed product use
- Verify a UL Recognized component use
- Verify a product safety standard

Learn more with the

[Quick Guide to the Online Certifications Directory](#)

SPECIFIC SEARCHES

(New! UL Evaluation Reports)

Select a specific search:

FEATURED LINKS

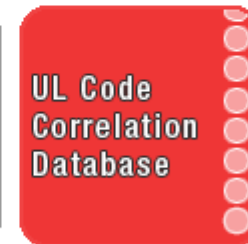

UL Anytime

We are ready to assist you at any time!



LINKS OF INTEREST

[UL Environment Database](#)

Labeling Requirements

Search results



Search results

You may choose to [Refine Your Search.](#)

Company Name	Category Name	Link to File
TECHNICAL GLASS PRODUCTS	Fire-protection-rated Glazing Materials	KCMZ.R13377
TECHNICAL GLASS PRODUCTS	Fire-protection-rated Glazing Materials Certified for Canada	KCMZ7.R13377

Model number information is not published for all product categories. If you require information about a specific model number, please contact [Customer Service](#) for further assistance.

[Search Tips](#)

[Print this page](#)

[Terms of Use](#)

[iQ Family of Databases](#)

Labeling Requirements

Fire-resistance Ratings - ANSI/UL 263

[See General Information for Fire-resistance Ratings - ANSI/UL 263](#)

Design No. U533

August 29, 2013

Non-Bearing Wall Rating—1 or 2 Hr (See Items 1, 2 and 6)

Framing connection to wall

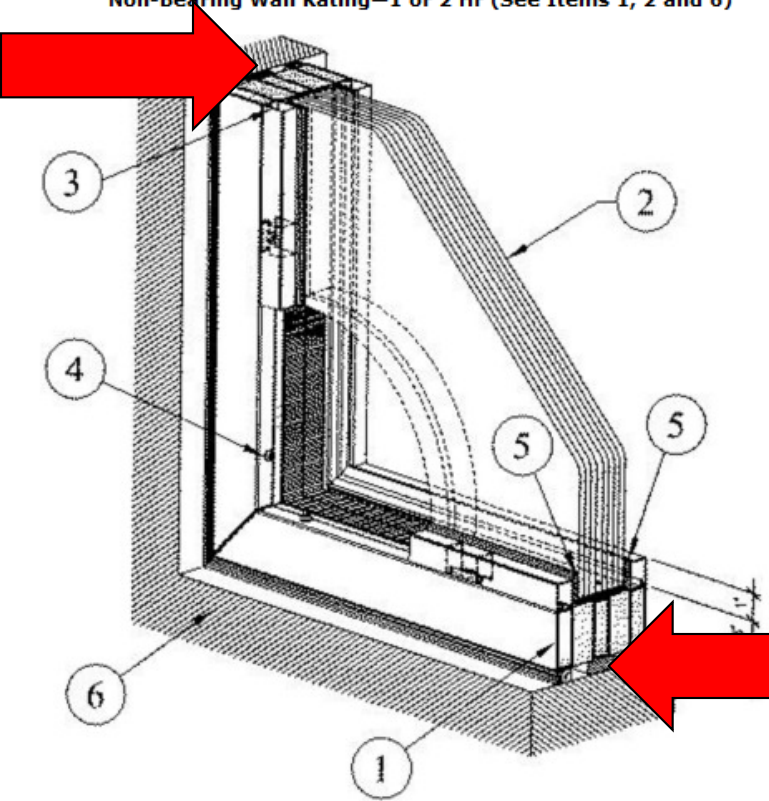

Framing connection to wall

Labeling Requirements

1. **Steel Framing Members*** — Nom 4-1/4 in. (2 hr /TGP 120) and 3-1/2 in. (1hr /TGP 60) wide with lengths cut according to glazing opening size. Secured to steel studs with No. 10, 4 in. long self drilling, self tapping buglehead screws spaced nominally 18 in. OC.

TECHNICAL GLASS PRODUCTS — Heat Barrier 60, Heat Barrier 120

2. **Fire Resistant Glazing Material*** — For 1 hr. assemblies - Nom. .85 in (23mm) minimum thickness laminated glass supplied in various sizes. Max size not to exceed 39 sq ft with max dimensions of 94-7/8 in. For up to 2 hr. assemblies - Nom. 1.57 in. (40mm) minimum thickness laminated glass panels supplied in various sizes. Max. size not to exceed 25.9 sq. ft. with max. dimension of 111 in.

PILKINGTON DEUTSCHLAND AG — Pyrostop 60-101 (23 mm), Pyrostop 60-161 (37 mm), Pyrostop 60-161VB, Pyrostop 60-201 (27 mm), Pyrostop 60-251 (41 mm), Pyrostop 60-251VB*, Pyrostop 60-351 (41 mm), Pyrostop 60-351VB*, Pyrostop 60-50 (Nom. 27 mm), Pyrostop 60-361 (41 mm), Pyrostop 60-361VB*, Pyrostop 60-261 (41 mm), Pyrostop 60-261VB*, Pyrostop 60-401 (56 mm), Pyrostop 120-104 (54 mm), Pyrostop 120-201 (56 mm), Pyrostop 120-202 (40 mm), Pyrostop 120-362 (54 mm), Pyrostop 120-362VB*, Pyrostop 120-262 (54 mm), Pyrostop 120-262VB*

*Products types marked with a VB may incorporate a Venetian Blind as part of the UL Classified Glazing Panel.

TECHNICAL GLASS PRODUCTS — Pyrostop 60-101 (23 mm), Pyrostop 60-50 (Nom. 27 mm), Pyrostop 60-201, (27 mm), Pyrostop 60-251 (41 mm), Pyrostop 60-251VB*, Pyrostop 60-351 (41 mm), Pyrostop 60-351VB*, Pyrostop 60-361 (41 mm), Pyrostop 60-361VB*, Pyrostop 60-261 (41 mm), Pyrostop 60-261VB*, Pyrostop 60-401 (56 mm), Pyrostop 120-104 (54 mm), Pyrostop 120-201(56 mm), Pyrostop 120-202, (40 mm), Pyrostop 120-362 (54 mm), Pyrostop 120-362VB*, Pyrostop 120-262 (54 mm), Pyrostop 120-262VB*

*Products types marked with a VB may incorporate a Venetian Blind as part of the UL Classified Glazing Panel.

Labeling Requirements

3. Glazing Beads — Supplied with the steel framing members. Nom 16 gauge steel beads of various sizes, cut to fit tightly along the perimeter of both sides of glazing material. Beads are friction fit in place over nom. 5/8 in. long panhead screw (Item 4).

4. Screws — 5/8 in. long panhead screws attached to steel framing members, spaced 12 in. OC per manufacturers installation instructions.

5. Neoprene Gasket — Nom 1-1/8 in. wide by 3/8 in. thick neoprene strip friction fit to seal and cushion legs of glazing beads (item 3) in contact with glazing material (Item 2).

6. Wall Assembly — The 1 or 2 hr fire rated wall assembly shall be constructed of the materials and in the manner described in the individual U300, U400, or U900-Series Wall or Partition Designs in the UL Fire Resistance Directory.

7. Silicone Sealant — (Not Shown)—In lieu of item 5. 100 percent silicone, rubber building and glazing sealant. A bead of sealant is applied between glazing bead (Item 3) and glazing material (Item 2) joint.

8. Shims — (Not Shown)—Nom. 3/4 in. wide by 1/8 in. thick hard fiber shims placed on bottom of glazing opening between glazing beads (Item 3) to set glazing material (Item 2).

9. Fill, Void or Cavity Materials* — (Not Shown) Caulking applied with caulking gun between wall opening and the frame to fill the cavity between the frame and the wall.

3M COMPANY 3M FIRE PROTECTION PRODUCTS — Type CP25 WBT

*Bearing the UL Classification Mark

Selecting Fire-Rated Glazing

Questions:

- What is the required fire-rating for the application?
- Does the glazing meet impact safety standards?
- Are there performance films or laminates?
- Are there any acoustic needs?
- Does the glazing material need to block the transfer of radiant heat?
- Is the glazing being installed into the proper framing assembly (matched fire-ratings)?
- Once the glazing has been selected, did you confirm the material has been tested by a testing agency such as UL and can be validated through that testing agency?

Non-Code Compliance Situations

- Non-tested assemblies
 - All components must have a complete laboratory listing
 - Fire-rated skylights
- Modified assemblies-must be installed EXACTLY as tested
 - Film on fire-rated glazing
 - Wood trim or other combustibles on a fire-rated frame
- Improperly tested products
 - Non-accredited testing lab
 - Partial testing of a product

Who installs these products?

- Glazing contractors
- Door installation contractors
- General contractors

Are there any needed qualifications / certifications?

No – detailed installation manuals accompany all projects

Case Studies



Project: University Hospitals, Seidman Cancer Center

Location: Cleveland, OH

Architect: Cannon Design

Products: 20-90 minute fire-rated steel doors and frames with 20-180 minute fire-rated, safety-rated glass ceramic

TGP Photos





Case Studies



Project: MultiCare Good Samaritan Hospital,
Dally Tower

Location: Puyallup, WA

Architect: Good Sam Design Collaborative, in
conjunction with Clark/Kjos Architects and GBJ
Architecture

Products: 45-120 minute fire-rated steel curtain
wall with 45-120 minute fire-rated, safety-rated
glass firewall

When facing a decision that affects life safety, make sure the products used meet all code requirements. Not all products are created equal.



